



Parts Included

Glass Panel(s) with Mounted Brackets & Edge Guards

Glass Panel - Front

Edge Guards
Do Not Remove until the installation is complete.

Glass Panel - Back

Top of panel is labeled
Glass panels have 2 or 3 permanently attached Panel Brackets (Fig. 5).

Glass Panel - Profile

Panel Bracket
Top Edge
Top Lip

Hidden Pen & Eraser Holder
Holds eraser & 4 markers

Open End
L brace: position towards center of panel
GlassGrip[®] Back: Peel & Apply behind desired panel edge.

Caution: Edge Sensitivity. Prevent forceful contact of panel edges and corners.
Note: Glass panels are heavy. Installation will require two or more people.

Micro Adjustment Standoff Wall Brackets

Standoff Bracket Shoulder
Standoff Bracket
Front Lip
Standoff Bracket Assembly
Wall Mounting Hardware (not included)

Leveling Screws

See 3a, Fig. 3 for assembly instructions

U Shim

Used to flush misaligned panel surfaces

Insert behind standoff bracket(s) when/if needed.

1. Wall Mounting Location and Measurements.

- Determine the location of your Glass WhiteWall[®] on the mounting wall.
 ⚠️ **Note:** A minimum 1" ceiling clearance is required to seat the panels onto the wall brackets.
- Subtract the Panel Height (P) from the desired height of the top edge of the glass wall (T) to determine the distance from the floor to the bottom edge of the glass wall (H).

$$T - P = H$$

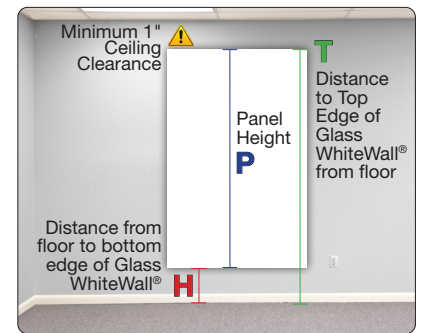

2. Panel Measurements and Wall Markings

Note: Fasten to wall studs when possible, use wall anchors as needed, see panel weights Fig. 5.

- Mark locations of wall studs along the full width of the intended mount area. (Fig. 1)
- Select a glass panel. Measure from the bottom edge of the panel to the Top Lip of each panel bracket (Fig. 2).
- Add measured distance "H" from step 1b to measurements from step 2b and mark the wall at these heights from the floor (Fig. 1).
- With a level, draw lines at the wall markings across all marked wall studs (Fig. 1).

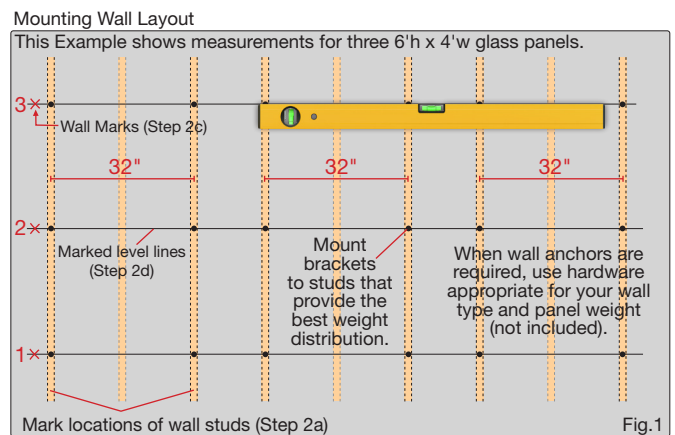
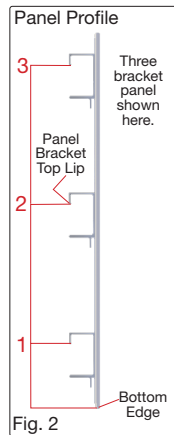

3. Standoff Brackets: Assembly and Wall Fastening

- Assembly:** Insert a Leveling Screw into each Standoff Bracket so that the end is flush with, but not higher than, the top edge of the front lip of the bracket (Fig. 3).
- Wall Fastening:** Using hardware appropriate for your wall type* (not included), fasten Standoff Brackets to the wall. Fasten to wall studs when spacing allows. Align bracket "shoulder" with the drawn level lines (Fig. 4).

*For best support, fasten to wall studs when available. The need for wall anchors will vary with panel sizing and wall panel count. Choose hardware appropriate for your wall type and panel weights (Fig. 5).

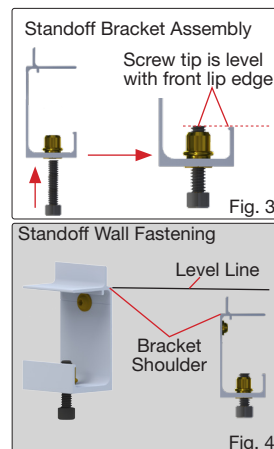

Bracket Counts & Mounting Layouts				
Panel Size (hwxw)	Panel Weight (lbs)	Per Panel Counts	Standoff Brackets	Single Panel Stud Spacing & Mounting Layouts
2' x 3'	27	2	4	16" 16"
3' x 2'	27	2	4	16" 16"
3' x 4'	54	2	4	32" 32"
4' x 3'	54	2	4	16" 16"
4' x 4'	74	2	4	32" 32"
4' x 5'	88	2	4	48" 48"
4' x 6'	100	2	6	32" 32" 32"
4' x 8'	127	2	8	32" 16" 32" 16"
5' x 4'	88	3	6	32" 32" 32"
6' x 4'	100	3	6	32" 32" 32"
8' x 4'	127	3	6	32" 32" 32"

● = Standoff Bracket Location ■ = Wall Stud Fig. 5



View INSTRUCTIONS & INSTALLATION VIDEO at Magnatag.com/WWG

4. Hanging the Glass Panels onto the Standoff Brackets

First: Fasten the GlassGrip®-backed Hidden Pen & Eraser Holder to left or right end glass panel at a convenient height. Peel clear film from the back, align Open End along the panel edge, with L Brace towards panel center and press into place Fig. 6.

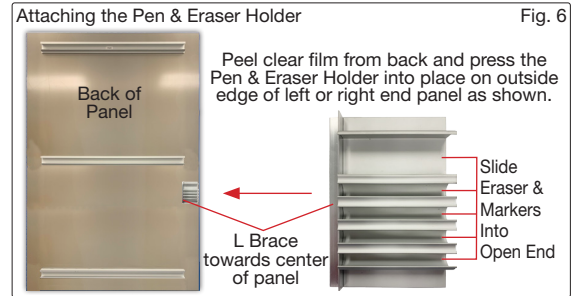

- a. With the help of at least one other person, mount the panels from left to right. Raise the glass panel so that the panel brackets are just above the wall-mounted standoff brackets. Carefully lower the glass panel onto the standoff brackets, engaging them as shown in Fig. 7.
- b. Viewing from the side, confirm the panel is fully seated, then check for level. If level, continue mounting subsequent panels, checking each for level. If panels are not level, make adjustments per step 5 below. Do not remove panel edge guards until the installation is complete.

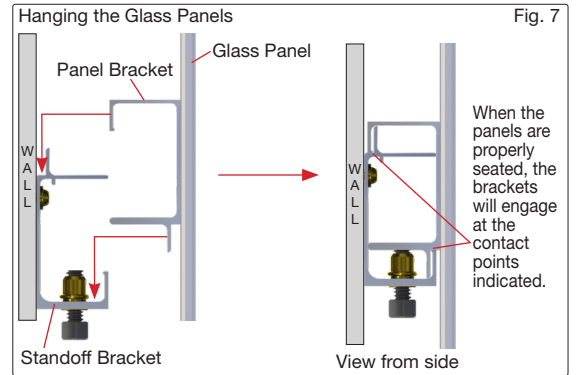

If Needed

5. Glass Panel Adjustments: Level Panels & Flush Seams

Level

After carefully removing the out-of-level glass panel, spin the leveler screw of the appropriate standoff bracket to raise the low side of the panel. Retest panel level and repeat as needed until the panel is level. See Fig. 8 for screw-turn decimal and fractional distance equivalents.

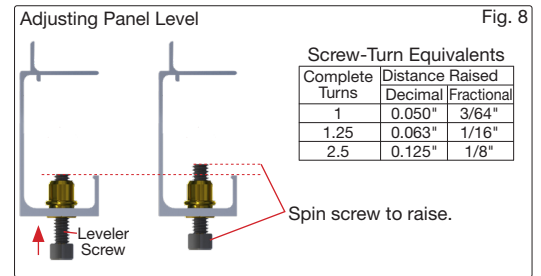

Flush

When glass panels are adjoined, compare the surfaces at the seam. If out of flush (uneven), remove the panel that needs to come forward and carefully set aside. Loosen the appropriate standoff bracket, slide a U shim behind as shown in Fig. 9 and refasten the bracket.

U Shims are 1/16" thick.

Remount the panel and re-check the seam for flush surfaces.

Repeat as needed until the seams are flush.

